

T
R
A
D
E

P
R
O
D
U
C
T

G
U
I
D
E



I
S
S
U
E

6

Welcome!

We're excited to bring you the Issue 6 of the Kingfisher Trade Product Guide.

In this edition, we'll be diving into the latest updates from across Kingfisher - including news on our people, products, services, and more. Whether you're on the shop floor or out in the field, there's something here for everyone.

Accreditations



Contents



2 About Us

3 Kingfisher News

5 Ask Technical

6 Environmental

40 Luminaire Accessories

55 Kingfisher Controls

52 Kingfisher Sport

56 Other Products Available

61 Technical Symbols

62 Glossary

63 Key Contacts

64 Index

9

15

21

27

35

44

50

STREET

AMENITY

BOLLARDS

WALL MOUNTED

FLOOD LIGHTS

COLUMNS

ACCESSORIES

About Us

Kingfisher Lighting has an outstanding reputation for high quality throughout our products and services. Working across the UK for over 35 years, we host a vast collection of luminaires, columns and accessories for many applications including street, amenity, architectural, area and sports lighting.



Maintenance

As lighting maintenance experts, we can help maintain a variety of systems, including both Kingfisher and non-Kingfisher schemes. With a specialised focus on sports and high mast, we can help you fulfil your legal obligations by ensuring your lighting systems are safe and performing at 100%.

Project Design Service

We offer a project design service including everything from simple plot calculations to true-to-life 3D visualisations. All lighting designs include detailed layouts of luminaire types, photometry, and lux values, perfect for larger projects. This ensures specification compliance and a seamless installation process.

Delivery

The Kingfisher Fleet is ready to go! Thanks to our large fleet, we can offer delivery nationwide, including areas with strict restrictions such as London. We hold FORS Silver accreditation and are EURO 6 compliant so we can deliver to logistically complex sites.

Call and Collect Service

Are you local or do you have your own fleet? Save time with our call and collect service. Simply call a member of the team and they'll advise time and dates with the possibility of same day collection!

Quick Reference Symbols



Warranty
We offer a 5-year warranty on all LED luminaires.



Upgraded
We continually upgrade our products to bring you the best performance at the best price.



New Product
See the latest products in our range.



From Stock
We stock hundreds of products which are ready to be delivered to your site anywhere in the country.



Call & Collect Service
Many of our products are held in stock and ready for you to collect the same day.



Kingfisher News

Fresh Updates. Trusted Products. One Unified Team.

In this issue, we're bringing you the latest from Kingfisher: including a major business update and the launch of our brand-new website. It's all part of our continued commitment to making things easier, faster, and better for your projects.

Kingfisher Lighting Ltd has officially merged into Luceco UK Ltd

What you need to know:

As of 1st April 2025, Kingfisher Lighting has officially merged into Luceco UK Ltd, part of the wider Luceco plc group. This move is designed to simplify trading - giving customers and suppliers one point of contact and one trading entity moving forward.

Operations continue as normal - same Kingfisher products, people, and service.

Your current pricing and rebate terms remain unchanged.

From now on, invoices will be issued by Luceco UK Ltd.

Purchase orders should be addressed to Luceco UK Ltd but sent to your usual Kingfisher contact.

Sales Director – Esther Newton

“As a division of Luceco, Kingfisher are in a stronger position than ever to support your projects with trusted lighting, end-to-end service, and a team that truly understands your needs.”

New Website Now Live

We're proud to launch our new and improved Kingfisher website, designed to give you faster access to the information and tools you need.

What's new:

- Dedicated Project Pages – Explore real-world installations and see our products in action.
- Product Sections – Easier navigation and improved filtering help you find what you need, faster.
- Resources Hub – Access datasheets, brochures, and technical guides, all in one place.
- Mobile-Friendly Design – Whether you're at your desk or on-site, the site works beautifully on any device.

Visit us at kingfisherlighting.com/uk/

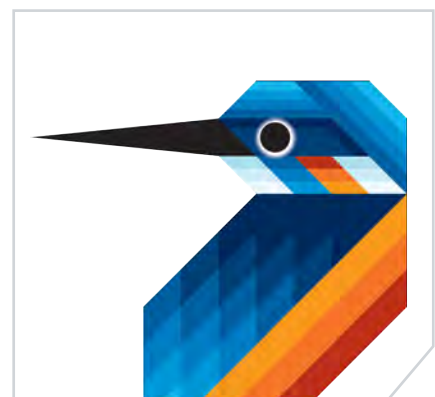

Lighting Design That Moves at Your Pace



Our team of expert lighting designers hold the highest standard of lighting design qualifications and training.

With continuous development in this area, our designers use their wealth of knowledge and state-of-the-art software to create energy efficient solutions whilst maintaining the perfect aesthetic for each individual project.

www.kingfisherlighting.com

Ask Technical

Welcome to Ask Technical, your go-to page for answers. Our Technical Team have answered your most frequently asked questions and provided clear, practical guidance to help you get the job done.

What is DALI, and how does it differ from traditional lighting control methods?

DALI stands for **Digital Addressable Lighting Interface**. It is a standardised protocol (IEC 62386) used for controlling lighting in building automation systems. DALI enables digital communication between lighting devices (like ballasts, drivers, sensors, and controllers), allowing more precise and flexible control compared to traditional methods.

Possibilities of DALI include:

- Scalability and flexibility in lighting design
- Energy efficiency through precise control
- Easier maintenance with diagnostics at device level
- Integration with building management systems



What types of add-on options are available for Kingfisher luminaires?

Kingfisher luminaires can be enhanced with a range of smart and practical add-on options, allowing you to tailor your lighting to the specific needs of your project — from energy savings and control to safety and compliance.

Available add-on options include:

- **PEC (Photoelectric Cell):**
Enables automatic dusk-to-dawn operation by detecting ambient light levels.
- **PIR (Passive Infrared Sensor):**
Activates lighting in response to motion, improving energy efficiency and security.
- **Kingfisher Controls:**
A suite of intelligent control solutions, including DALI systems and centralised lighting management.
- **EM (Emergency Module):**
Provides backup illumination during a power failure to meet emergency lighting requirements.
- **EMPRO (Self-Test Emergency Module):**
Advanced emergency module that performs automatic testing for easier compliance and maintenance.



What are Kingfisher Controls, and how do they work with your lighting products?

Kingfisher Controls is our suite of intelligent lighting control solutions, designed to offer seamless, smart operation of outdoor lighting schemes. These systems can include DALI-based setups, photocells, PIRs, and advanced central management.

Key benefits of Kingfisher Controls:

- Centralised control for multi-site projects
- Enhanced energy savings through adaptive lighting
- Remote monitoring and diagnostics
- Scalable from single installations to large-scale networks



Environmental

With the entire world focused on sustainability, Kingfisher Lighting is no exception. The lighting industry is responsible for 5% of global greenhouse gas emissions. However, we want to change that.

Kingfisher products and services undergo regular assessments to ensure we're keeping our carbon footprint as low as possible. We've incorporated circular economy models into several of our products and made adaptations to reduce single-use plastics in our packaging.



Circular Economy

From design to product release, we're focused on reducing the amount of waste produced every step of the way, so we've introduced circular models to our range. This ensures all elements of the luminaires can be replaced or recycled throughout the product's lifetime.



Did you know that we offer a FREE Circular Economy CPD?

Hosted by our expert team, we can provide a variety of insights into the circular economy and what to look out for when specifying lighting products.

DarkSky International

Do you ever look up to the sky at night, but you can barely see the stars? If yes, you're part of 80% of the world's populations that live underneath a light polluted sky.

DarkSky's mission is to eradicate light pollution by providing advice, guidance, and a list of reputable manufacturers who are officially 'DarkSky Approved'. Kingfisher Lighting is proud to be recognised among them, thanks to our smart designs and advanced optical solutions that carefully control light and minimise pollution.



Ecocentricity

Artificial light affects every species differently; some benefit, while others suffer. That's why we offer a diverse range of lighting solutions, including dim-to-warm options, varied colour temperatures, and single-spectrum luminaires. When applied appropriately, these products can significantly reduce the environmental impact of artificial lighting.



Research shows that warmer colour temperatures and single-spectrum lighting can support the well-being of humans, animals, and plants. Green wavelengths help birds, vegetation, and other flora thrive, while red and amber tones aid in preserving the natural circadian rhythms of bats and nocturnal species.

Sustainable Packaging

We've reduced single-use plastics by up to **96%** across our entire product range. In their place, we use recyclable materials, including responsibly sourced formed cardboard. Even small components like nuts and bolts are now packaged in paper bags, offering a thoughtful alternative to traditional plastic.





Costa Coffee - Sutton Road

We worked with Costa to deliver a lighting scheme that balanced performance, safety and brand consistency.

Using the **VIVA-CITY Pro** and **DECO 2.0**, we met required lux levels (25 lux in car parks / 50 lux in drive-throughs) while preserving their signature style.

This solution supported BREEAM compliance, minimised glare, and provided a seamless customer experience.



Street Lighting



10 AURIGA 2.0



11 VIVA-CITY Pro



12 I-TRON



13 CIRECO

AURIGA 2.0

AURIGA 2.0 Post Top is the contemporary luminaire bringing high performance functionality for roadways and pedestrian locations.



Scan for Datasheet



Key Features

- 20.0W - 120.0W
- 2,528 - 16,920 Luminaire Lumens
- Efficacy up to 149.0 lm/W
- 2700K, 4000K, CRI >70
- Lifetime >100,000hrs, L80
- IP66, IK08
- Comfort Option
- Photocell Options
- Emergency Options



Optics

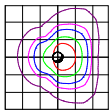
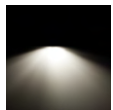

Asymmetric Street Optic - Area

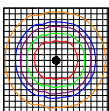
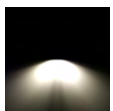

Symmetrical 90° Optic

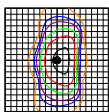
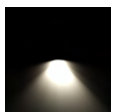

Street Optic - Wide

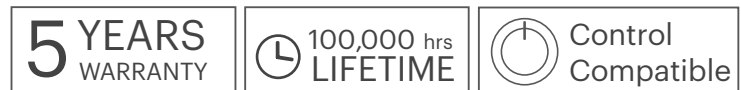

Dimensions

Body Size	A	B	C	D
Post Top	733	530	158	60/76

All dimensions in mm

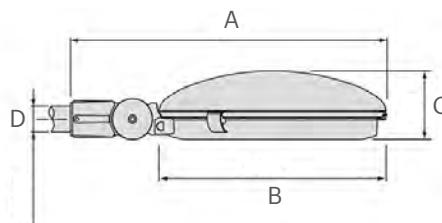



VIVA-CITY Pro

The VIVA-CITY Pro is a slimline street lantern with improved efficacy and output that incorporates asymmetrical optics including an area optic.



Key Features

- 10.0W - 180.0W
- 662 - 24,840 Luminaire Lumens
- Efficacy up to 149.0 lm/W
- 2700K, 4000K, CRI >70
- IP66, IK08
- Lifetime > 100,000 hrs, L80
- DarkSky Approved
- Dim-to-Warm Options



Optics



Forward Throw Optic 70°

Spill Shield Forward Throw Optic 70°

Street Optic 70°

Dimensions

Body Size	A	B	C	D
10W, 20W	525	250	106	60/76
40W, 60W, 80W	625	288	102	60/76
120W, 180W	775	320	102	60/76

All dimensions in mm

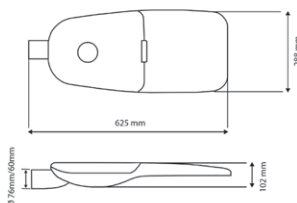

Scan for Datasheet

I-TRON

I-TRON is a high-performance street light. The modular lens and reflector based system with high-transparency tempered glass offers energy efficient, quality output.



Scan for Datasheet



Key Features

- 11.9W - 132.0W
- 1,560 - 19,410 Luminaire Lumens
- Efficacy up to 156.0 lm/W
- 4000K, CRI >70
- Lifetime >100,000 hrs, L94
- IP66, IK09
- Emergency Options
- Paint Finish Options
- Marine + Finish

Optics

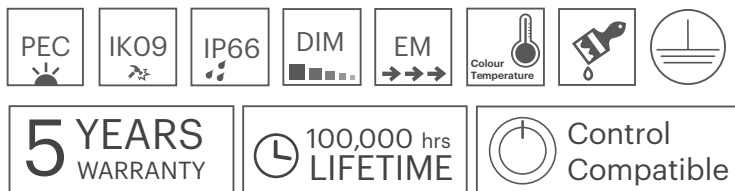
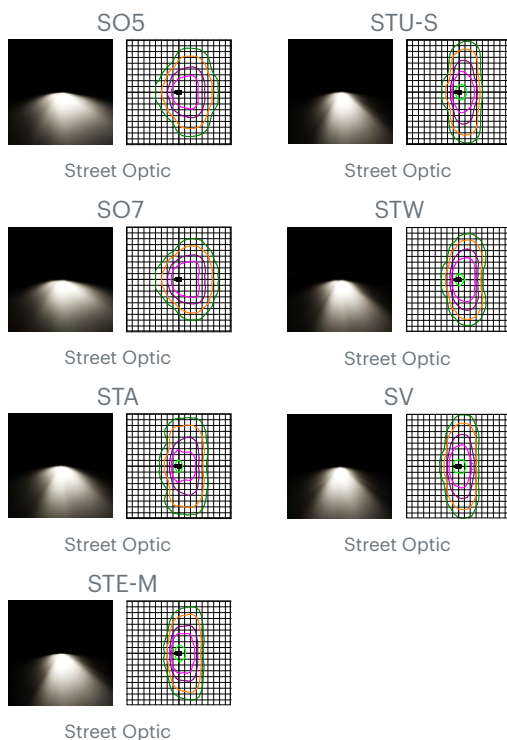

Dimensions

Body Size	A	B	C	D
Standard	535	345	93	60/76

All dimensions in mm

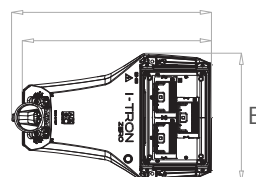
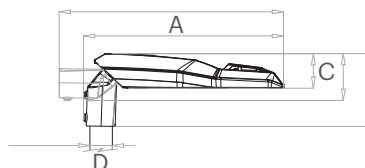

New Product ★ 5 Years Warranty From Stock Call & Collect

CIRECO

The dedicated circular economy luminaire, CIRECO is the street light designed to the ethos of 'reduce, reuse, recycle'. Featuring innovative LED technology, this fitting features Zhaga components to ensure your site is future proofed.



Key Features

- 25.0W - 75.0W
- 2,101 - 10,925 Luminaire Lumens
- Efficacy up to 153.0 lm/W
- 2700K, 4000K, CRI >70
- IP66, IK08
- Lifetime > 100,000 hrs, L80
- Circular Economy Model

PEC IK08 IP66 Colour Temperature Marine Grade Finish DALI

5 YEARS WARRANTY 100,000 hrs LIFETIME Control Compatible

Optics

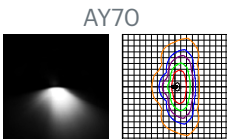

Street Optic 70°

Dimensions

Body Size	A	B	C	D
Standard	521	360	95	60

All dimensions in mm

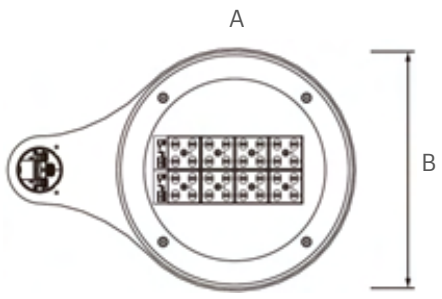

Scan for Datasheet



Mildenhall Hub

We supported Mildenhall Hub with a lighting design that combined safety, uniformity and low-glare performance.

A mix of ZACTIS, AURIGA 2.0, QUARTO 2.0 and VIVA-CITY Flood and Pro luminaires delivered consistent illumination across car parks, pathways and public areas, with integrated emergency modules enhancing site-wide safety.

The scheme prioritised visibility, reduced light spill and created a safe, welcoming environment for the community.



Amenity Lighting



16 VILLA II



17 SLOANE 2.0



18 AURIGA 2.0



19 CIVICA 2.0



VILLA II

The perfect lantern to add a heritage look to any scheme. VILLA II is available in LED as well as a range of colour temperatures to suit your applications.



Scan for Datasheet



Key Features

- 30.0W - 60.0W
- 3,450 - 7,270 Luminaire Lumens
- Efficacy up to 130.0 lm/W
- 2700K, 4000K, CRI >70
- IP66, IK08
- Lifetime > 100,000 hrs, L80
- Photocell Options
- Emergency Options

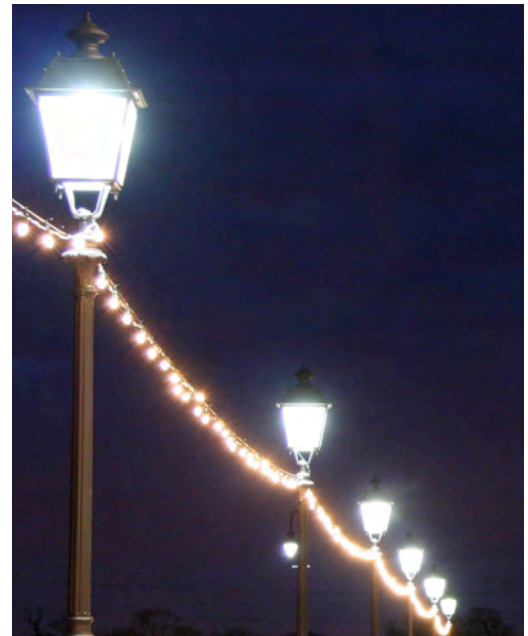

Optics

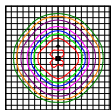

Symmetrical 127° Optic



Dimensions

Body Size	A	B	C	D
Standard	816	425	425	60/76

All dimensions in mm

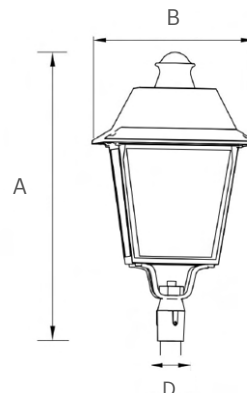



SLOANE 2.0

A spherical luminaire with an effective light distribution, SLOANE 2.0 is ideal for large area amenity applications



Key Features

- 35.0W - 55.0W
- 2,548 - 4,005 Luminaire Lumens
- Efficacy up to 73.0 lm/W
- 4000K, CRI >70
- IP65, IK10
- Lifetime > 100,000 hrs, L90
- Photocell Options



Optics

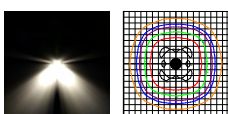

Symmetrical Distribution Optic

Dimensions

Body Size	A	B	C	D
Standard	500	0	520	76

All dimensions in mm

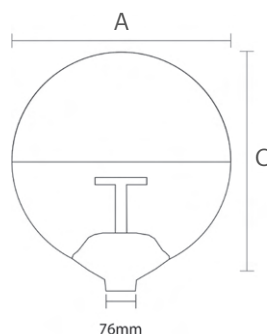

Scan for Datasheet



AURIGA 2.0

Featuring an elegant aesthetic, the AURIGA 2.0 Stirrup is a versatile solution with emergency, photocell, comfort and dim to warm capabilities to suit any modern site.



Scan for Datasheet



Key Features

- 20.0W - 60.0W
- 2,732 - 7,950 Luminaire Lumens
- Efficacy up to 149.0 lm/W
- 2700K, 4000K, CRI >70
- Lifetime >100,000 hrs, L80
- IP66, IK08
- Comfort Option
- Photocell Options
- Emergency Options



Optics

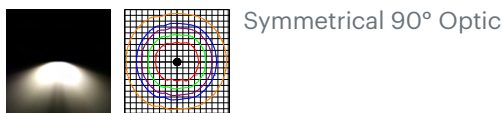
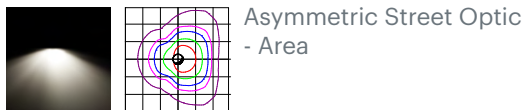

Dimensions

Body Size	A	B	C	D
Stirrup	737	530	158	60

All dimensions in mm

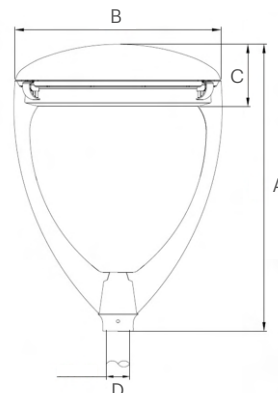



CIVICA 2.0

With a classic amenity shape, the CIVICA 2.0 is the robust luminaire that boasts comfort throughout many public realm applications, due to its prismatic diffuser and marine grade finish.

AMENITY



Key Features

- 40.0W - 60.0W
- 4,048 - 6,600 Luminaire Lumens
- Efficacy up to 110.0 lm/W
- 2700K, 4000K, CRI >70
- IP65, IK08
- Lifetime > 100,000 hrs, L80
- Diffuser Cone
- Photocell Options



5 YEARS
WARRANTY

100,000 hrs
LIFETIME

Control
Compatible

Optics

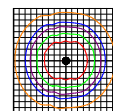
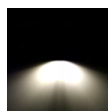

Symmetrical 90° Optic

Dimensions

Body Size	A	B	C	D
Standard	600	600	426	60/76

All dimensions in mm

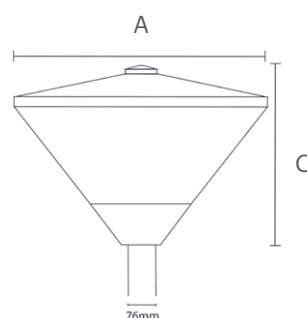

Scan for Datasheet



Wooldridge View

At Forest Pines, Kingfisher delivered a DarkSky-friendly, emergency compliant lighting scheme for 50 affordable apartments with 24/7 care support.

Using SEMITA wall luminaires, VALLO bollards, and ITALO post-tops, we achieved safe navigation, reduced light spill, and strong emergency backup.

The result is a low-glare, comfortable, and compliant scheme that enhances safety across paths, gardens, and parking areas.



Bollards



22 VAILO



24 HELVELLYN 2.0



25 DECO 2.0



VAILO

Kingfisher's Revolutionary Bollard

Lighting plays a pivotal role in creating safe, comfortable, and visually appealing spaces. VAILO is a sleek GRP bollard, designed with advanced optics to achieve spacings of up to 12 metres - delivering performance and efficiency across public realm, car parks, and infrastructure projects.

Smart Design

Developed by the Kingfisher Product Team, VAILO combines non-conductive GRP construction, low-glare output, and on-site adjustability, making it a versatile choice for a wide range of applications.

Outstanding Performance

- GPR Body: Non-conductive, marine-grade finish, ideal for Class II installations.
- Optics: UK-engineered for 8:1 spacings, with 2 lens options for pathways or area lighting.
- Adjustability: Switch between single or twin-sided illuminations to suit the site.
- Efficiency: Wider spacings mean fewer bollards, reducing installation, cost and energy.
- Ease of Install: Adjustable mounting plate, user-friendly tools and simple guides save time on site.

Options

Available in 2700K or 4000K, with full control compatibility, photocell and emergency options and pre-installed fuse cut-outs.





VAILO

VAILO is a sleek, low glare bollard offering a best-in-class optical system. Available with an array of lumen packages, as well as single or twin sided illumination and adjustable distribution on site.



Key Features

- 9.2W - 25.0W
- 251 - 2,282 Luminaire Lumens
- Efficacy up to 91.0 lm/W
- 2700K, 4000K, CRI >70
- IP66, IK10
- Lifetime > 100,000 hrs, L80
- Controls Compatible
- Photocell Options



5 YEARS WARRANTY		100,000 hrs LIFETIME		Control Compatible			

Optics

Area	Single Path	Twin Path
Radial	Pathway	Pathway

Dimensions

Body Size	A	B	C
Standard	190	109	1004

All dimensions in mm

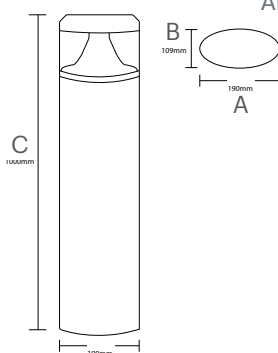

Scan for Datasheet

HELVELLYN 2.0

5 Years Warranty | From Stock | Call & Collect



Scan for Datasheet

The HELVELLYN 2.0 is a sleek, stainless steel bollard with an on-site adjustable output to optimise performance across sites. Available with photocell and emergency opportunities, HELVELLYN 2.0 is perfect for public realm locations.



Key Features

- 7.5W - 15.0W
- 730 - 1,860 Luminaire Lumens
- Efficacy up to 124.0 lm/W
- 2700K, 4000K, CRI >80
- IP65, IK08
- Lifetime > 50,000 hrs, L70
- Photocell Options
- Emergency Options



Optics

Radial

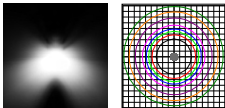

PEC | IK08 | IP65 | DIM | EM | Colour Temperature

5 YEARS WARRANTY | 50,000 hrs LIFETIME | Control Compatible

Dimensions

Body Size	A	B	C
Standard	180	0	1040

All dimensions in mm





DECO 2.0

A classic bollard with high versatility levels, the DECO 2.0 has an onsite adjustable output as well as photocell and emergency options to maximise site potential.



Key Features

- 7.5W - 15.0W
- 730 - 1,860 Luminaire Lumens
- Efficacy up to 124.0 lm/W
- 2700K, 4000K, CRI >80
- IP65, IK08
- Lifetime > 50,000 hrs, L70
- Photocell Options
- Emergency Options



5 YEARS
WARRANTY

50,000 hrs
LIFETIME

Optics

Radial

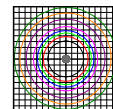

Dimensions

Body Size	A	B	C
Standard	180	0	1040

All dimensions in mm



Scan for Datasheet



Manor Street – Braintree, Essex

We worked with Braintree District Council to deliver a human-centric lighting scheme for the Manor Street regeneration.

Using MOD 2.0 Urban TP, MIKO bollards and QUARTO 2.0 wall packs, we enhanced comfort and visibility across the bus interchange, Town Hall Plaza and Travelodge.

This solution reduced glare, supported dementia-friendly design, and created modern, people-focused public spaces.



QUARTO 2.0

Wall Mounted



28

SEMITA Arc



32

ATLAS
EXTRA



29

SEMITA Urban



33

FORTIS



31

QUARTO 2.0



SEMITA Arc

Bring style and functionality to your schemes with SEMITA Arc.



Scan for Datasheet



Key Features

- 3.5W - 13.2W
- 336 - 1,615 Luminaire Lumens
- Efficacy up to 122.0 lm/W
- 2700K, 4000K, CRI >70
- IP66, IK10
- Lifetime > 100,000 hrs, L80
- DarkSky Approved
- Emergency Options

WALL MOUNTED

Optics

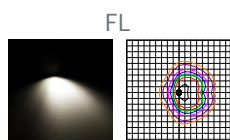

Flood Optic

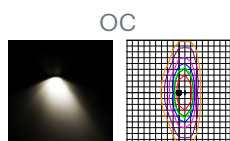

Path Optic

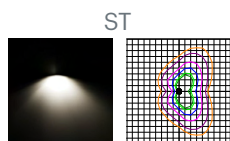

Street Optic



Dimensions

Body Size	A	B	C
Standard	240	230	158

All dimensions in mm

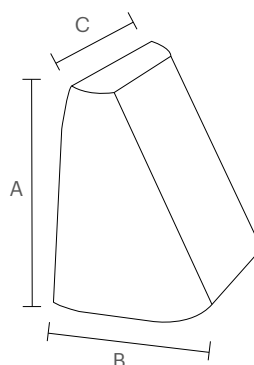

5 Years Warranty

From Stock

Call & Collect

SEMITA Urban

Designed and engineered in the UK, SEMITA Urban brings you the perfect balance of form and function



Key Features

- 3.0W - 11.0W
- 388 - 1,611 Luminaire Lumens
- Efficacy up to 146.0 lm/W
- 2700K, 4000K, CRI >70
- IK10, IP66
- Lifetime > 100,000 hrs, L80
- DarkSky Approved
- Emergency Options



5 YEARS WARRANTY

100,000 hrs LIFETIME



Optics

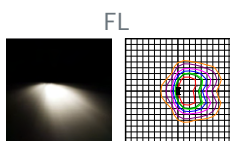

Flood Optic

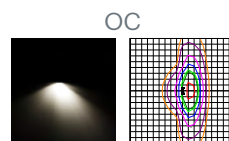

Path Optic

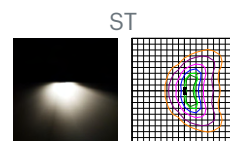

Street Optic

Dimensions

Body Size	A	B	C
Standard	337	148	82

All dimensions in mm

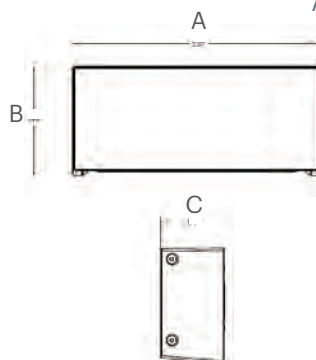

Scan for Datasheet

WALL MOUNTED



The Barnum – Nottingham City Centre

We delivered a contemporary lighting scheme for The Barnum, a modern residential development near Nottingham Train Station.

Using a mix of architectural and amenity luminaires, including TAURI, ELLIS 1 and QUARTO 2.0, we illuminated key entrances, walkways and building perimeters.

The scheme enhanced safety and wayfinding, minimised glare and light spill, and complemented the building's red brick façade to create a refined, high-quality residential environment.

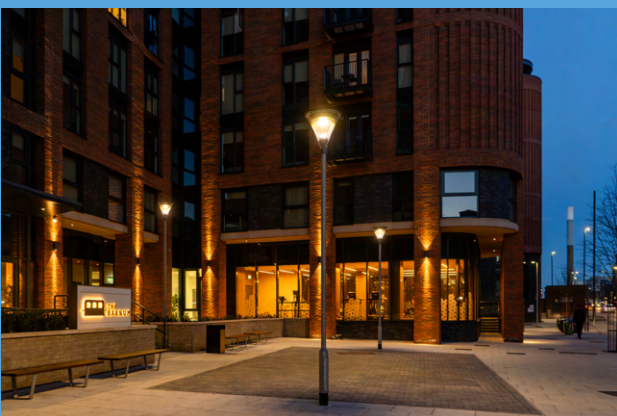
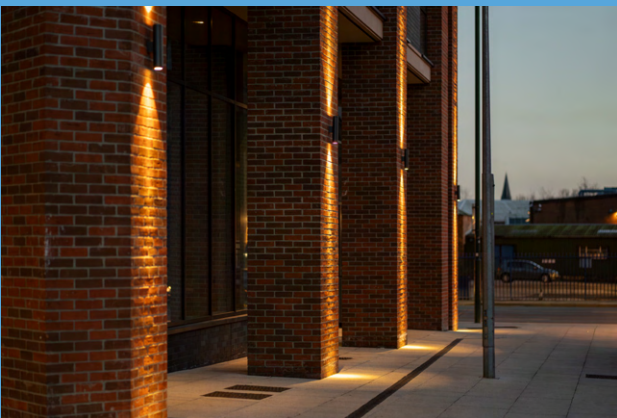

QUARTO 2.0



QUARTO 2.0

A stylish, modern bulkhead available with LED emergency and photocell. QUARTO 2.0 is suited to building and perimeter lighting.



Key Features

- 2.2W - 14.2W
- 206 - 1,720 Luminaire Lumens
- Efficacy up to 121.0 lm/W
- 2700K, 4000K, CRI >70
- IP66, IK10
- Lifetime > 100,000 hrs, L80
- Photocell Options
- Microwave Sensor Options
- Emergency Options



5 YEARS
WARRANTY

100,000 hrs
LIFETIME

Optics

FL

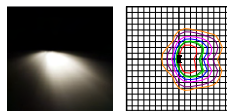

Flood Optic

OC

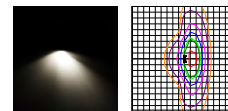

Path Optic

ST

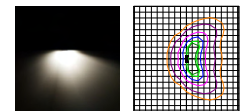

Street Optic

Dimensions

Body Size	A	B	C
Standard	231	230	230

All dimensions in mm

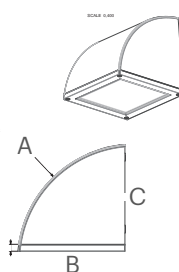

Scan for Datasheet

WALL MOUNTED

ATLAS Extra

Suitable for exterior and interior placements, the ATLAS provides a low impact distribution through the opal diffuser as standard.



Scan for Datasheet



Key Features

- 12.0W - 19.0W
- 1,200 - 2,100 Luminaire Lumens
- Efficacy up to 110.0 lm/W
- 2700K, 4000K, CRI >80
- IP65, IK08
- Lifetime > 50,000 hrs, L70
- Photocell Options

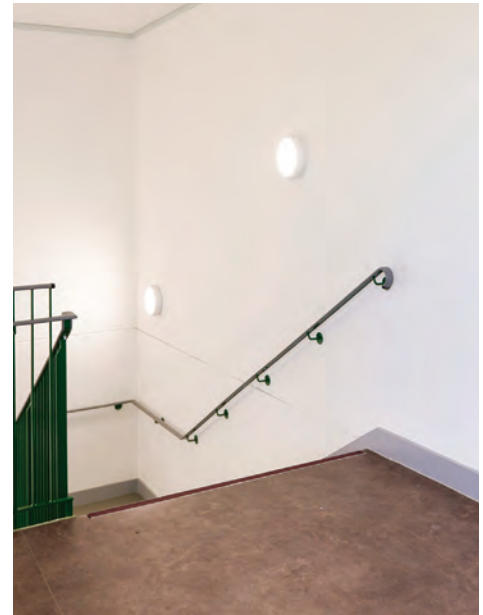

WALL MOUNTED

Optics

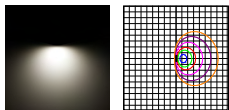

Asymmetrical Distribution



Dimensions

Body Size	A	B	C
Standard	340	340	105

All dimensions in mm

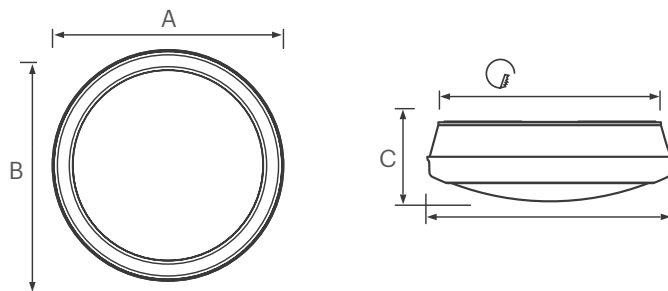

FORTIS

FORTIS is a versatile bulkhead perfect for illuminating building perimeters. Available with photocell, digital dimmable and emergency options, it is the ideal replacement for HID bulkheads.

Key Features

- 15.0W - 35.0W
- 1,500 - 3,500 Luminaire Lumens
- Efficacy up to 100.0 lm/W
- 4000K, CRI >80
- Lifetime >50,000hr, L70
- IP65, IK08



Optics

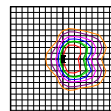
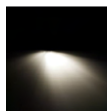

Asymmetrical
Distribution

Dimensions

Body Size	A	B	C
Standard	336	336	212

All dimensions in mm

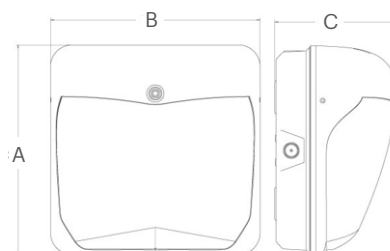

Scan for Datasheet



Abbey View Community Athletics

We retrofitted the club's outdated metal halide system with 24 AMNIS Flood luminaires, achieving 54% energy savings while meeting TrackMark Accreditation standards.

The new installation delivers 200+ lux across the track and infield, improving visibility, safety, and compliance for club-level competition.

Using existing infrastructure and smart scheduling, the project was completed with minimal disruption to club activity.

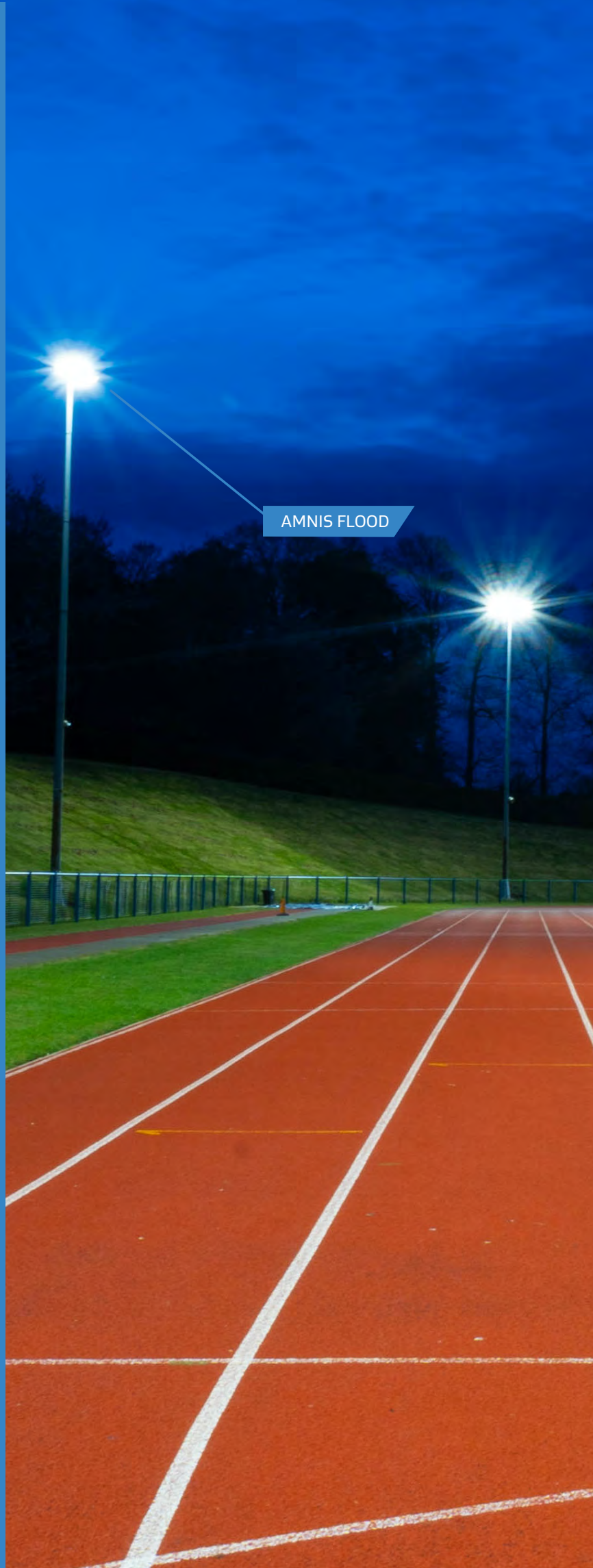

AMNIS FLOOD

Flood Lighting



36 VIVA-CITY Flood



37 VASTA



38 AMNIS Series



39 CARINA Urban

VIVA-CITY Flood

5 Year Warranty

From Stock

Call & Collect



Scan for Datasheet

Part of the VIVA-CITY family, the VIVA-CITY Flood is a sleek, powerful luminaire with asymmetrical distribution.



Key Features

- 60.0W - 120.0W
- 7,719 - 16,780 Luminaire Lumens
- Efficacy up to 143 lm/W
- 2700K, 4000K, CRI >70
- IP66, IK08
- Lifetime > 100,000 hrs, L80
- DarkSky Approved



Optics

FW70

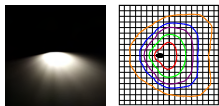

Forward Throw Optic 70°

FL50

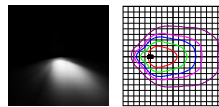

Flood Optic 50°



5 YEARS WARRANTY

100,000 hrs LIFETIME

Dimensions

Body Size	A	B	C
Standard	488	386	81

All dimensions in mm

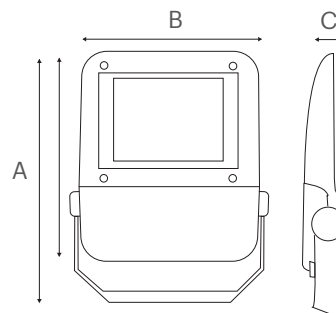



VASTA

VASTA is a high performance, highly efficient flood light perfect for wide area applications. Flat-to-ground and available in lower colour temperatures, it is perfect for areas where light obtrusion is a concern.



Key Features

- 125.0W - 481.0W
- 21,042 - 73,362 Luminaire Lumens
- Efficacy up to 189.0 lm/W
- 2700K, 4000K, CRI >70
- IP66, IK08
- Lifetime > 100,000 hrs, L90
- Photocell Options
- Flat-to-Ground
- NEMA and Zhaga Compatible



Optics

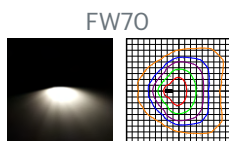

Forward Throw Optic 70°

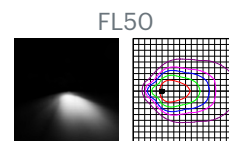

Flood Optic 50°

Dimensions

Body Size	A	B	C
Standard	548	654	112

All dimensions in mm

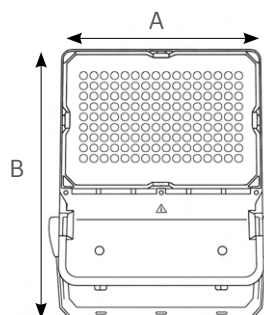

Scan for Datasheet

AMNIS Series



A powerful, high-performance luminaire designed and engineered in the UK offering a pitch perfect output and outstanding efficiency.

Scan for Datasheet



Key Features

- 450.0W - 1300.0W
- 47,439 - 188,662 Luminaire Lumens
- Efficacy up to 150.0 lm/W
- 2700K, 4000K, CRI >70
- Lifetime > 100,000 hrs, L70
- IP66, IK08
- Flicker Free, HDTV Ready
- Tier 1 Integral or Separate Driver Options
- IP68 Potted Driver Housing with Independent Surge Protection

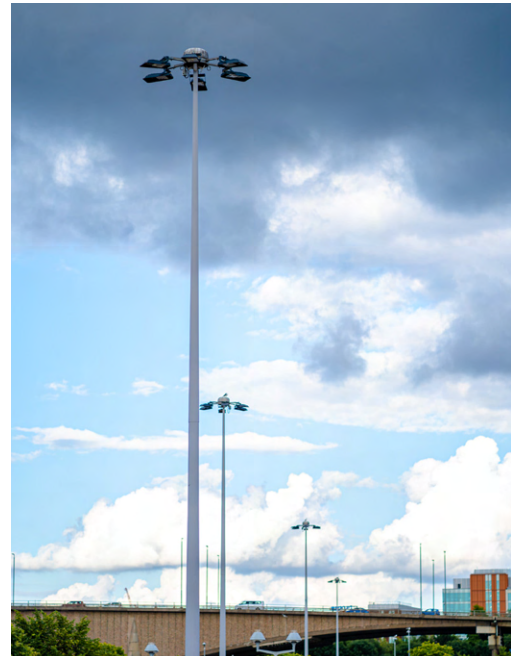

Optics

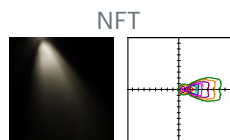

Narrow Far Throw

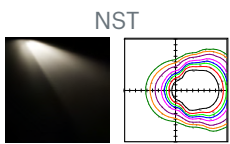

Narrow Short Throw

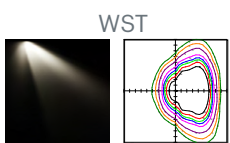

Wide Short Throw



Dimensions

Body Size	A	B	C
Match	461	808	278
Flood	700	840	153

All dimensions in mm

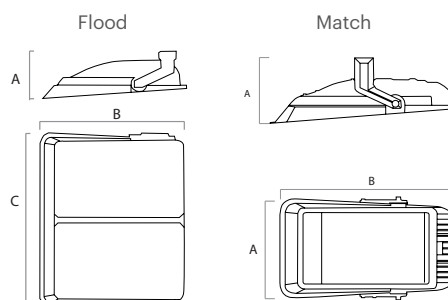



CARINA Urban

CARINA Urban is a simple, yet high quality flood perfect for small service yards and entry ways.



Key Features

- 50.0W - 150.0W
- 8,179 - 26,004 Luminaire Lumens
- Efficacy up to 173.0 lm/W
- 4000K, CRI >70
- IP66, IK08
- Lifetime > 70,000 hrs, L80
- Photocell Options



5 YEARS
WARRANTY

100,000 hrs
LIFETIME

Optics

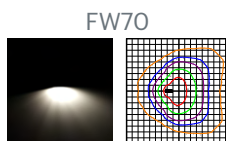

Forward Throw Optic 70°

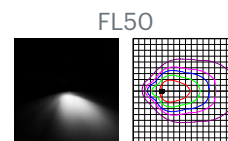

Flood Optic 50°

Dimensions

Body Size	A	B	C
Standard	488	386	81

Refer to datasheet

All dimensions in mm

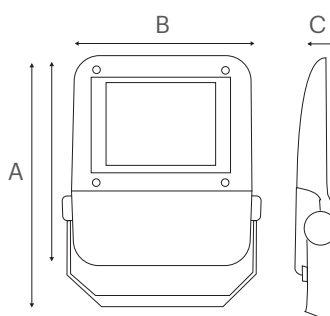

Scan for Datasheet

Luminaire Accessories

– Explained



EM (Emergency Module):

Provides backup lighting in case of a power outage, ensuring safety and compliance with regulations.



PEC (Photoelectric Cell):

Automatically switches lighting on/off based on ambient light levels for dusk-to-dawn operation.



MS (Microwave Sensor):

Detects motion using microwave technology, offering more precise detection than traditional PIR in some environments (e.g., enclosed spaces or through light materials).



PIR (Passive Infrared Sensor):

Activates lighting in response to heat-based motion detection — ideal for energy-saving and security.



D2W (Dim to Warm):

Delivers a controlled shift from 4000K to 2700K over time, reducing visual impact at night while maintaining functional illumination.



Comfort Optics:

Lighting optics designed to reduce glare and improve visual comfort, especially in public or residential areas.



Painting:

Custom paint finishes available to match project aesthetics or meet architectural requirements.



Single Spectrum:

Fixed colour temperature lighting, offering consistent, standardised output for applications where dynamic colour isn't required.





Broadford Hospital, Isle of Skye

We delivered the exterior lighting scheme for the Isle of Skye's latest community hospital, part of NHS Highland and Hub North (Scotland's) £40m development.

Using ITALO, SEMITA Urban, CLIMATE Extra and PLATINUM luminaires on 6m marine-grade columns, we lit car parks, roads, pathways, entrances and the ambulance wash. Emergency fittings, robust finishes and tailored optics ensure safety, uniformity and efficiency across the site.



ITALO 1

Columns, Brackets and Accessories



44 Columns



48 Amenity and Highway Brackets



49 Flood Light Brackets



50 Accessories



Lighting Columns

Built to Last

With over 30 years of experience, Kingfisher offers a wide range of lighting columns for street lighting, car parks, residential areas, and high mast applications.

Expert Support from Start to Finish

Our team will help you choose the right combination of columns, brackets, and luminaires to meet your project needs. With support from our in-house lighting designers, we ensure your lighting scheme meets required lux levels and uniformity.

Hinged Column Options

Ideal for areas with limited access, our base and mid-hinged columns allow safe maintenance from ground level using a winch or pulley system. No lifting equipment required.

Nationwide Delivery

Our fleet includes specialist hi-ab vehicles for safe and efficient offloading. Orders over £500 qualify for free delivery across mainland GB, with some regional exclusions.

Strong Stock Levels and Custom Finishes

We carry a large stock of columns and provide in-house fabrication. A variety of finishes and RAL colour options are available to match the style of your project.

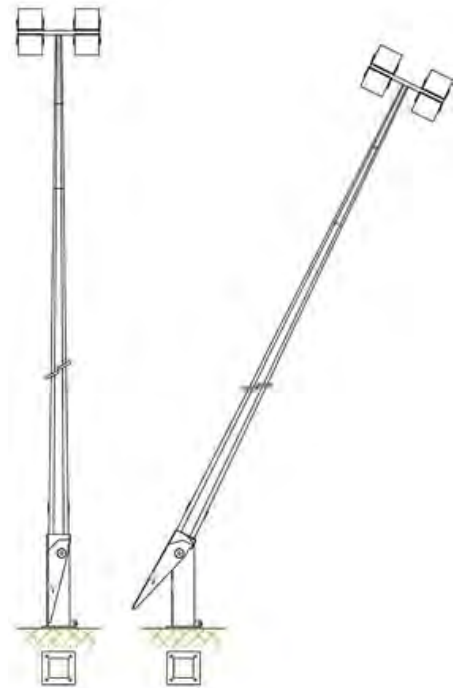

Column Types and Shapes

We offer a wide selection of high-quality steel lighting columns, built to suit various applications from residential streets to large-scale flood lighting.

Tubular Steel Columns

Heights: 3m to 12m

Versatile and reliable, these columns are ideal for residential, street, and amenity lighting.

- Root or flange plate mounting options
- External access door
- Available in standard or base-hinged versions (depending on height required, limited heights are available for base-hinged)
- Manufactured from steel tube with a tapered joint between shaft and base



Conical Steel Columns

Heights: 4m to 8m

A modern, tapered design suited to amenity and residential settings, with a clean and slimline aesthetic.

- Smooth cone shape, circular and tapered from base to top
- Flush-fit access door laser cut into the column body
- Available as root or flange plate mounted
- Multiple paint and finish options available

Octagonal Steel Columns

Heights: 4m to 15m

Designed for durability, these columns are ideal for supporting heavier luminaires and bracket systems.

- Tapered octagonal profile, press bent and fully welded
- Depending on height required, limited heights are available for base-hinged
- Built for strength and structural stability



Our Columns and Bracket range



A range of lighting tubular, conical, hinged columns, masts, flood light and amenity brackets.

Nationwide delivery.
Dedicated fleet.
Kingfisher gets it there.

www.kingfisherlighting.com



Broadford Hospital, Isle of Skye

Amenity and Highway Brackets

Our bracketry is manufactured in-house at Kingfisher HQ, using high-grade steel and hot dip galvanising for lasting durability. We offer a wide selection of brackets suitable for amenity lighting, highway applications, floodlighting, and more.

Working closely with you, our Technical Design and Fabrication Teams can produce bespoke solutions tailored to your project's exact specifications.

With proven performance in harsh weather conditions, Kingfisher brackets are built to last and provide complete peace of mind.

Amenity Brackets

Designed to securely support amenity luminaires, this range includes classic bracket types such as:

- **Single Column Adaptor 'AB1'**
- **Precinct 'AB'** – Straight outreach design for single or twin luminaires
- **Crescent 'BB'** – Smooth curved profile
- **Crescent 'BBD'** – Down curve variant with aesthetic flexibility

These options support both single and twin fittings, with directional variants to suit different schemes and fitting types.



Single column adaptor 'AB 1'

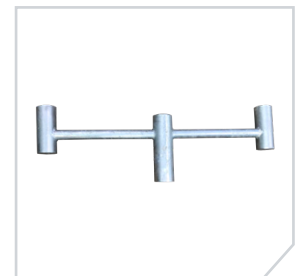

Precinct 'AB'



Crescent 'BB'

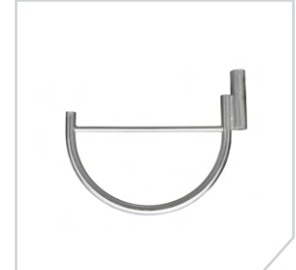

Crescent 'BBD'

Highway Brackets

Our highway brackets are ideal for side-entry luminaires. Available with 500mm single or twin outreach arms:

- **Single Reach 'SR'**
- **Double Reach 'DR'**

These reliable options are simple, strong, and well-suited for road and infrastructure projects.



Single Reach 'SR'



Double Reach 'DR'



Flood Light Brackets

Built for strength and durability, our flood light brackets are designed and manufactured in-house at Kingfisher HQ to handle the weight and demands of high-output floodlighting. All brackets are made from high-grade steel with a hot dip galvanised finish as standard. For coastal or high-exposure environments, we also offer a marine-grade finish for added protection.

We supply **single, twin, triple, and quad arm brackets**, all of which can be painted to any RAL colour to match site requirements. Our fabrication and technical teams are also on hand to create bespoke solutions for more complex projects.

Every bracket is supplied with the necessary fixings for secure installation, ensuring maximum stability and strength on site.

Bracket Options

- Single flood light bracket 'STM1'
- Twin flood light bracket 'STM2'
- Triple flood light bracket 'STM3'
- Quad arm flood light bracket 'STM4'



Single flood light bracket 'STM1'



Twin flood light bracket 'STM2'



Triple flood light bracket 'STM3'



Quad arm flood light bracket 'STM4'



Accessories

Complete your lighting scheme with our range of reliable and practical accessories. Designed to support installation, enhance durability, and improve site safety, our accessories cover everything from cable termination to impact protection.

Fuse Cut Outs

Our fuse cut-outs are fully compliant with **BS 7654** and provide secure termination for incoming and outgoing PVC and SWA cables. Made from high-spec thermoplastic, they're suitable for single-phase supplies with fuses ranging from **6A** to **20A**.



Column Guards

Protect columns in high-traffic areas with our robust guard options. Designed to reduce damage from vehicle impact, these are ideal for **car parks, retail environments, and industrial sites**.



Feeder Pillars

Feeder pillars provide a weatherproof housing for control gear and cable terminations. Available in various sizes and finishes, we also offer **pre-wired options** to simplify on-site installation.



Impact Kit

Developed to prevent bollard damage, our impact kits withstand compression loads over **100kg**, helping to protect fittings and maintain site safety.



Spill Shields

With obtrusive light a growing concern, we offer both internal and external **spill shield solutions** for some of our most popular luminaires. These help minimise spill and back light, supporting compliance and visual comfort.





Kingfisher SPORT and HIGH MAST

A division of the LUCECO group

Developed to meet the demand for high-performance, long-lasting solutions, Kingfisher Sport & High Mast is your go-to for reliable, large-scale lighting.

With a strong portfolio of completed projects across schools, sports clubs and national venues, we deliver lighting that performs when it matters most. Our powerful floodlight and accessories range is designed to meet key governing body standards including FA, RFU and LTA.

From sports grounds to logistics hubs, our high-performance fittings ensure optical precision, minimise light spill and meet the needs of both performance and compliance. Popular ranges such as the AMNIS Series and our new VASTA Series offer flexible mounting, smart control options and are stocked and ready to go.

At Kingfisher HQ, we keep wide availability across our core sport and high mast ranges, making it easy for contractors and wholesalers to specify, install and maintain with confidence.

To find out more, please contact sport@kingfisherlighting.com





Montrose FC, Scotland



Montrose Port, Scotland



Kingfisher CONTROLS

A division of the LUCEC© group

Lighting control should be simple, reliable and built around your needs. At Kingfisher, we offer a range of control options designed to suit all kinds of projects, from single-site installations to large-scale rollouts.

Whether you're lighting car parks, public streets or commercial spaces, our solutions help reduce energy use, cut maintenance and keep your lighting working exactly how you need it. . .

Photocell

Photocells are a popular and low-maintenance option for external lighting. They detect changes in natural light, automatically switching lights on at dusk and off at dawn. This means your lighting is always running when it needs to be, without any manual input or complicated scheduling. It's an efficient and cost-effective way to keep your site safely lit all year round.



Microwave Sensor (MS)

Microwave sensors detect movement using high-frequency signals, offering more accurate coverage than traditional motion sensors. They work well in enclosed or covered areas such as stairwells, car parks or service corridors, and can even detect motion through thin materials. This makes them ideal for spaces where consistent detection is key.



Passive Infrared Sensor (PIR)

PIR sensors respond to body heat, activating lighting only when someone is nearby. This makes them a great energy-saving choice for areas with low or occasional footfall, such as pathways, storage zones or external access points. They're simple, effective and help ensure your lighting is only used when it's needed.



Dim to Warm (D2W)

Dim-to-Warm control uses a pre-installed control node to manage a gradual shift in colour temperature, transitioning from a cooler 4000K at switch-on to a warmer 2700K later in the evening. This creates a softer, more comfortable light for night-time use and is ideal for spaces where ambience and visual comfort matter, such as residential environments, public realm and architectural lighting.



Other Ranges

With over 70 years of experience in the industry, Luceco are one of the leading manufacturers of commercial lighting and carry a wide range of LED lighting products, including commercial recessed options, high bay fixtures and emergency signage as well as domestic offerings such as flood light and household lamps.



With a large distribution and logistics centre based in Telford, Luceco are able to provide fast turn-around to meet demand.

Twinspots

A range of emergency twinspots for high-level lighting. This product offers non-maintained operation with twin heads for maximum coverage. The heads are adjustable to ensure the coverage area can be adapted to suit the needs of the area. Offering 3 hours of maintained operation, and backed up by a 3-year warranty, safety is assured with the Luceco Twinspots.

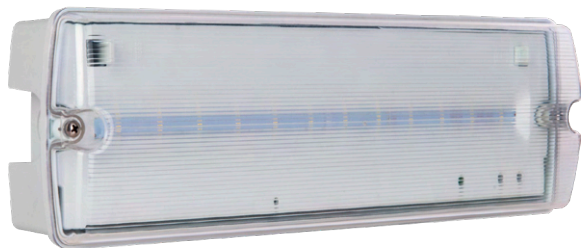

Tempus Bulkhead

A range of emergency bulkheads, the Tempus Bulkhead solutions offer a wealth of benefits. Constructed in polycarbonate with a clear diffuser, the Tempus Bulkheads offer additional protection through their IP65 rating. The bulkheads can be wall or ceiling mounted and provides 3 hours of maintained or non-maintained operation. With a cool white colour temperature of 6500k, the Tempus Bulkheads are suitable for a range of different projects.

Ceres

Ceres is a comprehensive range of industrial luminaires manufactured with a diecast aluminium housing which offers increased thermal performance. Lumen options range from 11000 to 35,500 in two, three or five rows of housing. With an IK10 rating and a lifespan of 100,000 hours, Ceres is built to last.







Other Ranges



We have enjoyed an exclusive partnership with the Italian brand, AEC Illuminazione for 25 years and can offer a vast range of high-quality luminaires perfect for high spec projects and schemes. The AEC range boasts everything from powerful street fittings to spectacular architectural luminaires

NOOS

A bold new addition to AEC's urban lighting range, NOOS combines architectural impact with energy-efficient performance. Its modular, vertical design makes it ideal for modern cityscapes, delivering both style and function.



FALKO

Compact, contemporary, and efficient, FALKO is a next-generation floodlight suited to both amenity and architectural applications. With clean lines and advanced optics, it offers powerful performance in a streamlined housing.

STYLO

Award-winning and visually distinctive, STYLO features innovative reflector technology for precise distribution. A sleek, high-performance solution for modern exterior lighting schemes.



ARTELYS

This versatile lantern series offers a wide range of options to accompany any heritage project. Pair with decorative columns and bracketry to further enhance the aesthetic of the project without compromising on quality or performance.

MOD 2.0 Bollard

Offering clean lines and low-glare comfort, the MOD 2.0 Bollard provides effective illumination for paths, parks, and perimeter lighting with a minimalist touch. create unique projects.



Other Ranges

Exclusive partners for over 25 years, Arcluce are high-end architectural lighting specialists with a culture of high quality and creativity. All Arcluce products are created using the latest technologies and with cutting-edge components that guarantee reliability and long-lasting efficiency.



PANDA

With its compact form and clean lines, PANDA is a wall-mounted luminaire that blends seamlessly into architectural settings. Ideal for walkways and building façades, it offers uniform, glare-controlled illumination with a modern finish.

KLOU Series

The KLOU Series features robust ground-recessed luminaires built for architectural and landscape lighting. With a variety of beam angles and IP ratings, it's a flexible solution for highlighting paths, trees, walls, or sculptures.



DUEVENTI

Designed for visual comfort, DUEVENTI is a compact luminaire perfect for pathways and landscaped areas. With a robust body and glare-controlled optics, it delivers subtle, functional illumination.

TULA

TULA brings contemporary flair to façade and accent lighting. This compact spotlight features precision optics and multiple beam angles, offering flexibility for architectural projects and display areas.



LUNIO7

Sleek and modern, the LUNIO7 delivers wide, even illumination for urban and amenity spaces. Its slimline profile, impact resistance, and customisable options make it a favourite for public realm schemes.



Technical Symbols

Here's a quick guide to our technical symbols ensuring your product meets specification every time.



IP55
Dust protected and 6.3mm water jet protected.



IP65
Dust tight and 6.3mm water jet protected.



IP66
Dust tight and 12.5mm heavy water jet protected.



IP67
Dust tight and water immersion beyond 1m.



IK
Degrees of protection provided by enclosures for electrical equipment against external mechanical impacts as per EN62262.

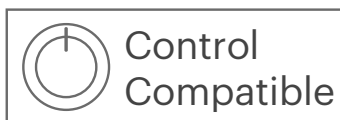

Controls Compatible



Class 1
These appliances must have their chassis connected to electrical earth.

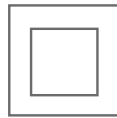

Class 2
Double insulated, does not require a safety connection to electrical earth.

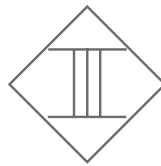

Class 3
Supplied from a separated/safety extra low voltage power source.



LED
Available with LED.



Dimming
Suitable for dimming.



RGB
Available with RGB colour changing.

BREEAM

There are 3 credits available for external lighting

Pol 04 Reduction of night time light pollution

Aim – To ensure that external lighting is concentrated in the appropriate areas and that upward lighting is minimised, reducing unnecessary light pollution, energy consumption and nuisance to neighbouring properties.

Assessment criteria – The external lighting strategy has been designed in compliance with Table 2 (and its accompanying notes) of the ILP Guidance notes for the reduction of obtrusive light, 2011.

Hea 01 Visual comfort

Aim – To ensure daylighting, artificial lighting and occupant controls are considered at the design stage to ensure best practice in visual performance and comfort for building occupants.

Assessment criteria – External lighting. All external lighting located within the construction zone is designed to provide illuminance levels that enable users to perform outdoor visual tasks efficiently and accurately, especially during the night. To demonstrate this, external lighting provided is specified in accordance with BS 5489-1:2013 Lighting of roads and public amenity areas 3 and BS EN 12464-2:2014 Light and lighting – Lighting of work places - Part 2: Outdoor work places.

Ene 03 External lighting

Aim – To recognise and encourage the specification of energy efficient light fittings for external areas of the development.

Assessment criteria – The average initial luminous efficacy of the external light fittings within the construction zone is not less than 60 luminaire lumens per circuit Watt.

*Kingfisher Lighting Ltd offer a 5-year warranty on all LED luminaires (excluding Inground series) on the basis that they are installed and operated in accordance with the manufacturer's instructions and within all thermal, electrical and environmental limitations. Any modifications made to the product by the customer will invalidate the warranty. Kingfisher Lighting Ltd reserve the right to repair or replace products at their discretion. Replacement of products does not include costs associated with installation. Terms and conditions apply.

Note: All Kingfisher products are CE and UKCA Marked and Comply with UK and European health, safety and environmental legislation.
Disclaimer: We reserve the right to make any changes to any product or information in this product guide at any time.
All images are for illustrative purposes only and colours may vary. ©Kingfisher Lighting Ltd. 2023.

Glossary

Beam Angle - Indicates how light spreads from a fitting. Narrow beam angles (e.g. 15°) create focused light; wider beams (e.g. 90°+) are ideal for general illumination.

Catenary Lighting - Luminaires suspended on tensioned cables across open areas like streets or courtyards – popular in modern public realm schemes.

Colour Rendering Index (CRI) - Measures how accurately a light source shows colours compared to natural daylight. CRI 70 is standard for outdoors, 80 or 90 is available from Arcluce and other selected ranges on request.

Colour Temperature (CCT) - Defines how “warm” or “cool” white light appears, measured in Kelvin (K).

- 2700K–3000K = warm white (cosy, residential)
- 4000K = neutral white (commercial, car parks)
- 5000K–6500K = cool white/daylight (industrial or exterior)

Driver - Regulates power to LED luminaires. Modern drivers often include smart functions like dimming, diagnostics, or wireless control.

Efficacy (lm/W) - Measures how efficiently a luminaire converts power into light. Expressed in lumens per watt (lm/W). High efficacy = better energy savings.

Emergency Lighting - Battery-backed lighting that activates during power loss for safety. Includes self-testing, addressable and wireless options in 2025 systems.

Flicker-Free - Describes luminaires that avoid visible or invisible flicker, improving comfort and avoiding potential health impacts (especially in sport).

Glare - Discomfort caused by excessively bright or poorly directed lighting. Measured using UGR (Unified Glare Rating). Good lighting design reduces glare.

Human-Centric Lighting (HCL) - Lighting designed to support wellbeing and productivity by mimicking natural daylight patterns. Common in offices, healthcare and education settings.

IK Rating - Measures how resistant a fitting is to impact. IK10 is the highest rating – typically used for urban, transport, and high-risk environments.

IP Rating - Defines a product’s protection against solids and liquids.
E.g. IP66 = fully dust-tight and protected against powerful water jets – essential for exterior fittings.

Lumen (lm) - Unit of luminous flux – tells you how much visible light a fitting emits. Higher lumen output = brighter fitting.

Lux - Measures how much light reaches a surface. Lighting designs use lux levels to meet regulations and ensure safe, usable spaces.

Mounting Height - The distance from the ground to the light source. Key to achieving correct distribution, glare control, and uniformity.

Obtrusive Light - Light that spills into unintended areas (e.g., windows or wildlife zones). Modern optics and compliance with BS EN 13201 reduce this.

Smart Lighting - Lighting systems that can be controlled via apps, schedules, or building management systems. Includes wireless mesh networks and cloud-connected control.

Spigot - A cylindrical connector (usually 34mm, 60mm or 76mm) used to mount luminaires onto brackets or columns.

Uniformity - The consistency of light spread across a surface. High uniformity means fewer dark spots and better visual comfort.

Upward Light Output Ratio (ULOR) - Shows how much light is emitted upwards. Zero ULOR means full cut-off – important for dark-sky compliance.

Windage / Wind Area - The surface area of a product exposed to wind. Used in column and bracket calculations to ensure safe structural design.



Distribution Sales

General Number - Distribution Sales

T: 01623 415900
E: sales@kingfisherlighting.com

All Regions

T: 01623 415904
T: 01623 415210

Northern Distribution Sales Representative

T: 07917 398216

Southern Distribution Sales Representative

T: 07974 454604

- Scotland**
 T: 01623 415925
- N. Ireland & Republic of Ireland**
 T: 01623 415921
- North West**
 T: 01623 415946
- Yorkshire & North East**
 T: 01623 392276
- East Midlands & Lincolnshire**
 T: 01623 392274
- East Anglia**
 T: 01623 415925
- West Midlands**
 T: 01623 415924
- Northern Home Counties**
 T: 01623 415902
- South West**
 T: 01623 415916
- London & South East**
 T: 01623 415917 T: 01623 415949

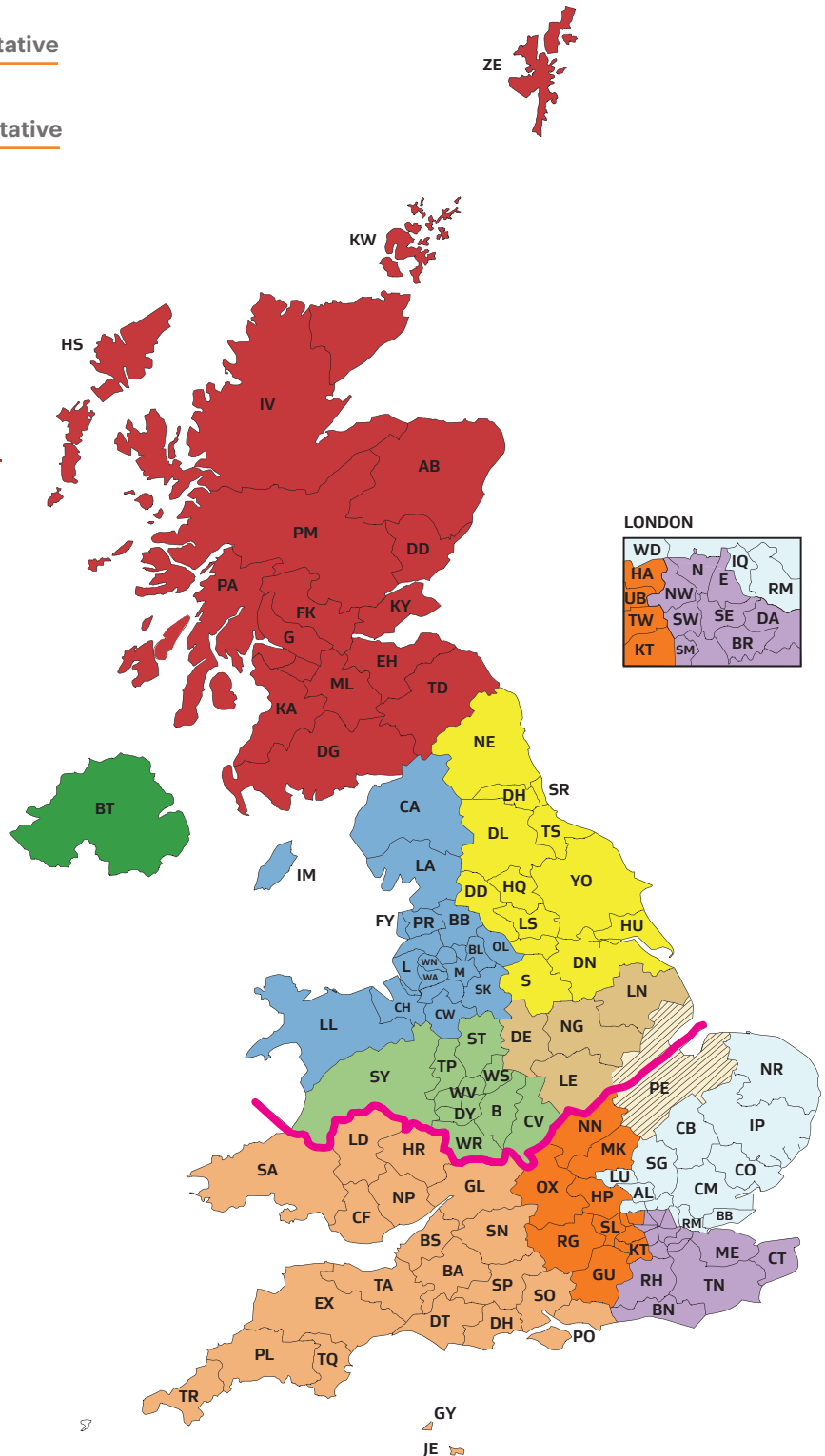

Product Index

A	About Us	2	K	Key Contacts	63
	Accessories	50		Kingfisher Controls	55
	Amenity and Highway Brackets.	48		Kingfisher High Mast	52
	Amenity Lighting	15		Kingfisher Sport	52
	AMNIS Series	38	L	LUCECO	56
	Ask Technical	5		Luminaire Accessories	50
	ATLAS EXTRA	32	M	Motion Sensor	40
	AURIGA 2.0 (Post Top)	10	O	Other Products Available	59
	AURIGA 2.0 (Stirrup)	18	P	Photocell	55
B	Bollards	21		PIR	55
C	CARINA Urban	39	Q	QUARTO 2.0	31
	CIRECO	13	S	SEMITA Arc	28
	CIVICA 2.0	19		SEMITA Urban	29
	Columns Guards	50		Single Spectrum	41
	Columns	46		SLOANE 2.0	17
D	DECO 2.0	25		Spill Shields	51
	DIM to Warm	41		Street Lighting	9
E	Emergency	40	T	Technical Symbols	61
	Environmental	6	V	VASTA	37
F	Feeder Pillars	50		VAILO	23
	Flood Light Brackets	49		VILLA II	16
	Flood Lighting	35		VIVA-CITY Flood	36
	FORTIS	33		VIVA-CITY Pro	11
	Fuse Cut Outs	50	W	Wall Mounted	27
H	HELVELLYN 2.0	24			
I	Impact Kits	51			
	I-TRON	12			

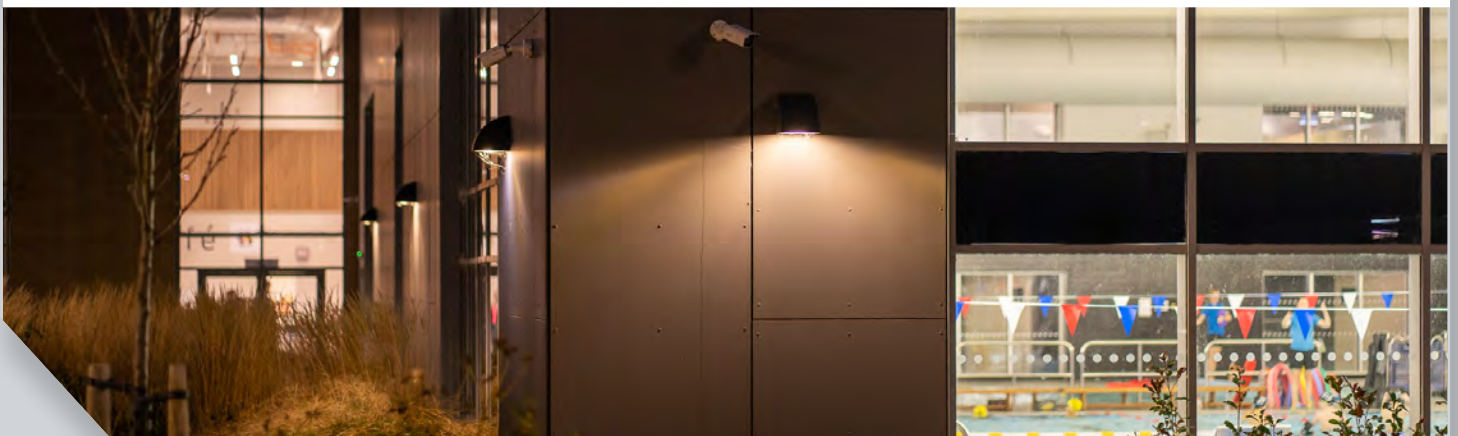

Our range of available guides



We work with a range of customers such as wholesalers, contractors, specifiers, designers, local authorities and end-users.

A range of available guides can be found on our website.



www.kingfisherlighting.com



Kingfisher Lighting
Kingfisher House
Crown Farm Way
Crown Farm Industrial Park
Nottinghamshire
NG19 0FT
T: +44 (0)1623 415900
E: sales@kingfisherlighting.com
kingfisherlighting.com